

Shelly

Explore the
POSSIBILITIES

PRODUCT CATALOGUE

SMART HOME & FACILITY AUTOMATION

Make your home and facility smart

Shelly is a line of home automation devices that allows customers to control their home directly through a mobile phone or with a preferred home assistant. Shelly's devices are retrofit, which makes them suitable for every electrical installation with no need of additional changes or improvements.

With Shelly you can:

- Control the lights by adjusting brightness, colors, and set custom schedules.
- Control the home appliances or office equipment from anywhere.
- Save energy and money with precise power metering.
- Set custom automation features.
- Monitor temperature, humidity, and brightness.
- Receive immediate notifications in case of any status changes.
- Power consumption control

All Shelly devices are designed to offer maximum comfort of living, safety and easy installation.




Global structure

 **Munich, Germany**
Sales & Marketing DACH

 **Boca Raton, USA**
Sales & Marketing North
& South America

 **Sofia, Bulgaria**
R&D, Sales,
Marketing, Admin,
Warehouse

 **Shenzhen, China**
Sales and Marketing Asia,
Supply Chain and factory
supervision

 **Shenzhen, China**
Production of 80% of
Shelly products

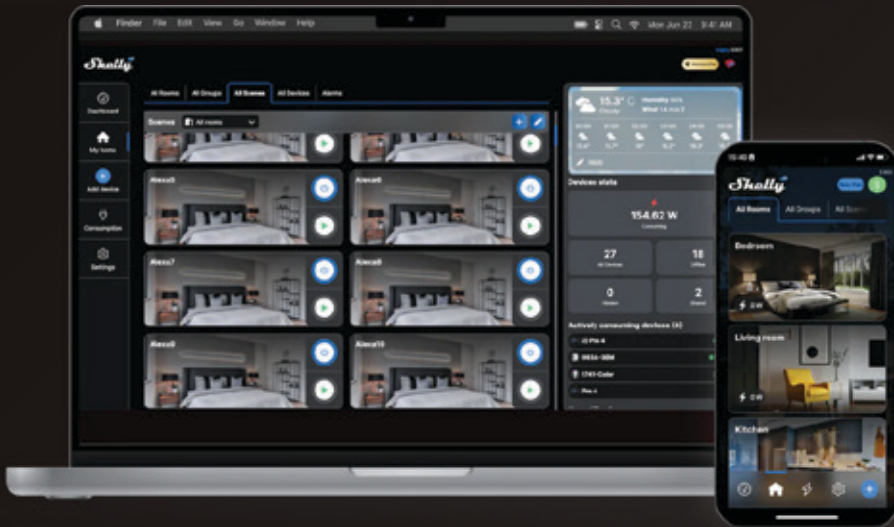
 **Nova Gorica
Slovenia**
R&D, Marketing
Shelly WAVE

 **Vietnam**
Production
of Shelly Chip





Shelly Smart Control



Easy device inclusion

Custom dashboards

Smart schedules & scenes

Compatible with Alexa

Energy monitoring

Electricity bills control

 Premium


AI Models


Offline Device Notifications


Virtual Devices

Integrations

Voice Assistants



Home Automation Platforms



Home Assistant



Homey



openHAB



Domoticz



ioBroker



Node-RED



Symcon



Nymea



Hubitat



HomeSeer

Protocols & APIs



MQTT



REST API



CoAP



mDNS



HTTP/HTTPS



Matter

Supported for Gen3 & Gen4 devices



Zigbee

Supported from Gen4 devices

KNX net/IP Integration



Tasmota



ESPHome



Control4



Crestron



URC

Typically Used For...



Lights



Heating & Cooling



Appliances



Doorbell



Irrigation



Garage Door



Pool automation



Power monitoring



Floor heating



Water manifolds



Cover & Blinds



Load shedding



Valves



Energy monitoring



Energy saving



Photovoltaic



Electric chargers



No neutral installation



Dimming



LED strips



Color



Scene activation



Room management



Centralized control



Thermostat



Motion detection



Leak & Gas detection



Region standards

GLOBAL

Majority of markets

UK

United Kingdom

EU

European Union

ANZ

Australia + New Zealand

US

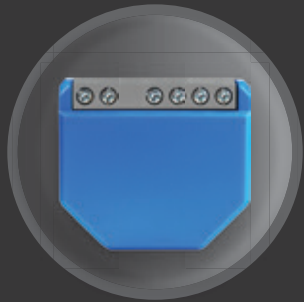
United States

IT

Italy



Switch & Socket Box Types



60 mm

Depth 45-70 mm

EU Standard Wall Box

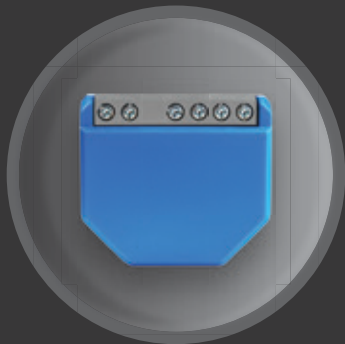


51 mm / 2"

76 mm / 3"

Depth 64-89 mm 2.5"-3.5"

US + Canada Gang Box



67 mm

Depth 35-40 mm

Danish Wall Box



115 mm

75 mm

Depth 50 mm

Italian Box



86 mm

86 mm

Depth: 25 mm (shallow) or 35 mm (standard)

UK Back Box



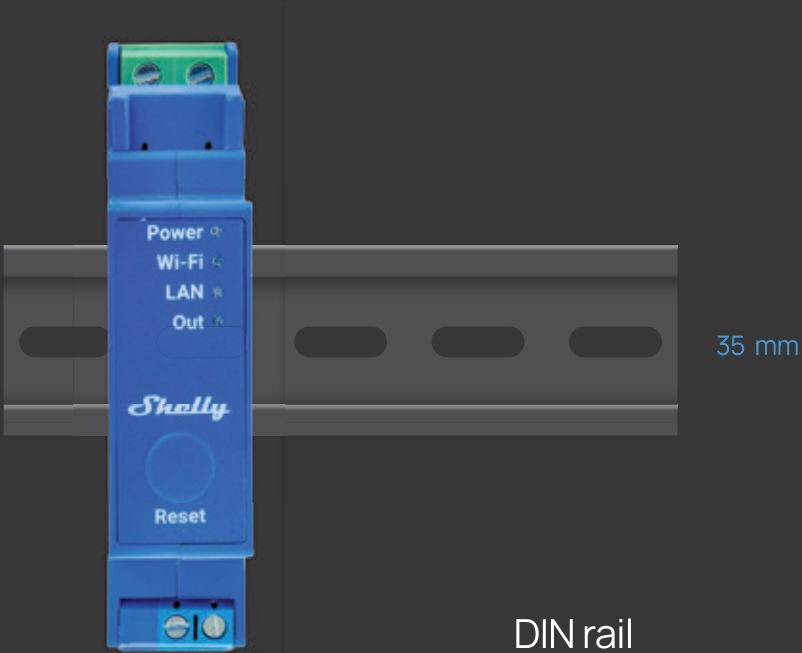
118 mm

74 mm

Depth ~50 mm

Australian / New Zealand Wall Box

Pro devices on DIN rail



Connectivity



Wi-Fi 4

Control and monitor your smart devices remotely without a hub using an existing Wi-Fi network.

Frequency: 2400 - 2483.5 MHz

Max RF power: < 20 dBm

Operational range:

- Up to 30 m / 100 ft indoors
- Up to 50 m / 160 ft outdoors



Wi-Fi 6

Control and monitor your smart devices remotely without a hub using an existing Wi-Fi network.

Frequency: 2401 - 2473 MHz

Max RF power: < 20 dBm

Operational range:

- Up to 30 m / 100 ft indoors
- Up to 50 m / 160 ft outdoors



Bluetooth 4.2

Add devices quickly and easily via Bluetooth, and enjoy fast, hassle-free setup without additional hubs.

Frequency: 2400 - 2483.5 MHz

Max RF power: < 4 dBm

Operational range:

- Up to 10 m / 100 ft indoors
- Up to 30 m / 160 ft outdoors



Bluetooth 5.0

Add devices quickly and easily via Bluetooth, and enjoy fast, hassle-free setup without additional hubs.

Frequency: 2402 - 2480 MHz

Max RF power: < 20 dBm

Operational range:

- Up to 10 m / 100 ft indoors
- Up to 30 m / 160 ft outdoors



Zigbee

Use a reliable, low-power Zigbee mesh network for extended coverage. A Zigbee hub is required.

Protocol: 802.15.4

Frequency: 2405 - 2480 MHz

Max RF power: < 20 dBm

Operational range:

- Up to 100 m / 328 ft indoors
- Up to 300 m / 984 ft outdoors



Z-Wave

Ensure a secure Sub-GHz smart home integration through a trusted mesh network. A Z-Wave hub is required.

Protocol: Z-Wave

Frequency: 868.4 MHz [EU]; 908.4 MHz [US]; 919.8 MHz [ANZ]

Max RF power: < 25 mW

Operational range:

- Up to 40 m / 131 ft indoors



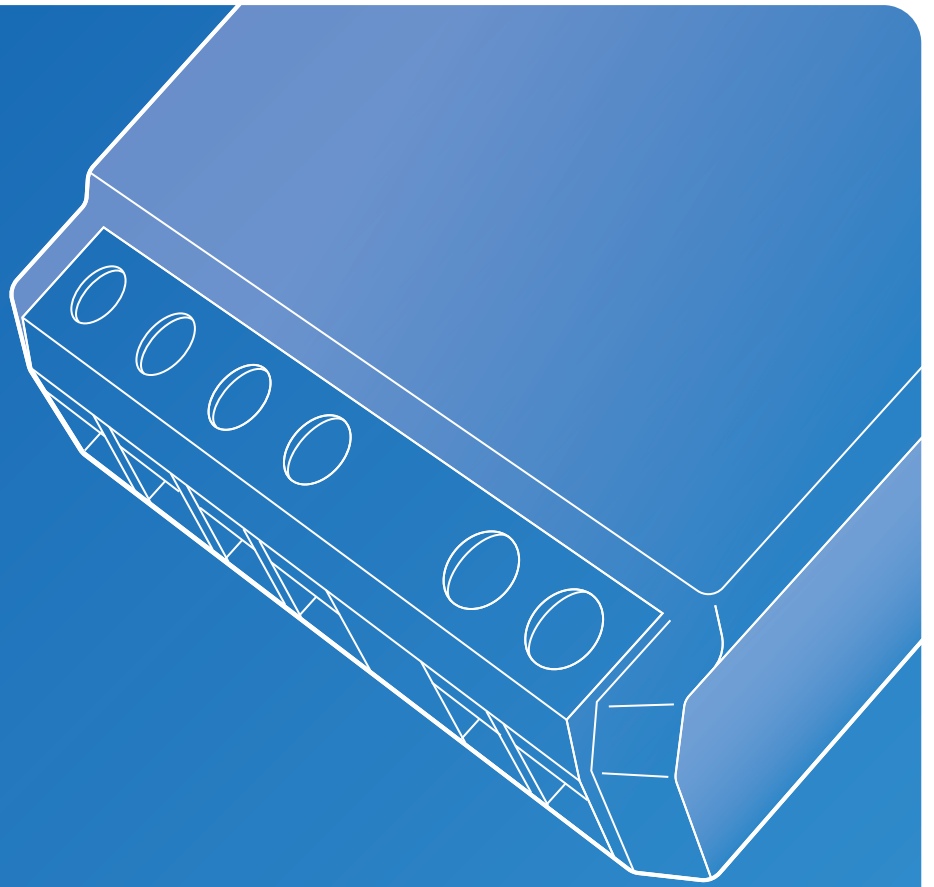
Matter

Integrate your Shelly devices into any major smart home platform like Apple, Google, or Alexa—no custom setup needed.



LAN

A wired, ultra-reliable connectivity



1 channel relays with dry contact

TYPICALLY USED FOR



Lights



Heating & Cooling



Appliances



Doorbell



Irrigation



Garage Door



Pool automation



GLOBAL



Shelly 1 Gen3



Power supply 110-240 V~ / 24-48 V== / 12 V==

Max load 16 A (240 V~); 10 A (30 V==)

Connectivity Wi-Fi 4
Bluetooth 4.2

CPU ESP-Shelly-C38F

Flash Memory 8 MB

Size (HxWxD) 37x42x16 mm / 1.46x1.65x0.63 inch

Weight 26 g / 0.92 oz

Certifications RED, LVD, EMC, ROHS



[more info →](#)

GLOBAL



Shelly 1 Gen4



Power supply 110-240 V~ / 24-48 V== / 12 V==

Max load 16 A (240 V~); 10 A (30 V==)

Connectivity Wi-Fi 6
Bluetooth 5
Zigbee 802.15.4
Z-Wave

CPU ESP-Shelly-C68F

Flash Memory 8 MB

Size (HxWxD) 37x42x16 mm / 1.46x1.65x0.63 inch

Weight 26 g / 0.92 oz

Certifications RED, LVD, EMC, ROHS



[more info →](#)

EU

US

ANZ



Shelly Wave 1



Power supply 110-240 V~ / 24-48 V== / 12 V==

Max load EU: 16 A (240 V~); 10 A (30 V==); US: 15 A; ANZ: 16 A

Connectivity Z-Wave EU: 868.4 MHz
Z-Wave US: 908.4 MHz
Z-Wave ANZ: 919.8 MHz
Z-Wave® S800

CPU

Flash Memory 512 kB

Size (HxWxD) 37x42x16 mm / 1.46x1.65x0.63 inch

Weight 26 g / 0.92 oz

Certifications RED, LVD, EMC, ROHS

EU ANZ

US



[more info →](#)



GLOBAL



Shelly 1 Mini Gen3



Power supply 110-240 V~

Max load 8 A (240 V~); 5 A (30 V==)

Connectivity Wi-Fi 4
Bluetooth 4.2

CPU ESP-Shelly-C38F

Flash Memory 8 MB

Size (HxWxD) 29x34x16 mm /
1.34x1.11x0.63 inch

Weight 19 g / 0.65 oz

Certifications RED, LVD, EMC, ROHS



[more info →](#)

GLOBAL



Shelly 1 Mini Gen4



Power supply 110-240 V~

Max load 8 A (240 V~) ; 5 A (30 V==)

Connectivity Wi-Fi 6
Bluetooth 5
Zigbee 802.15.4

CPU ESP-Shelly-C68F

Flash Memory 8 MB

Size (HxWxD) 29x34x16 mm /
1.34x1.11x0.63 inch

Weight 19 g / 0.65 oz

Certifications RED, LVD, EMC, ROHS



[more info →](#)

EU

US

ANZ



Shelly Wave 1 Mini



Power supply 110-240 V~

Max load 8 A (240 V~) ; 5 A (30 V==)

Connectivity Z-Wave EU: 868.4 MHz
Z-Wave US: 908.4 MHz
Z-Wave ANZ: 919.8 MHz

CPU Z-Wave® S800

Flash Memory 512 kB

Size (HxWxD) 29x34x16 mm /
1.34x1.11x0.63 inch

Weight 19 g / 0.65 oz

Certifications RED, LVD, EMC, ROHS



[more info →](#)



GLOBAL



Shelly Pro 1



Power supply 110-240 V~

Max load 16 A / 15 A UL Version

Connectivity Wi-Fi 4
Bluetooth 4.2
LAN

CPU ESP32-D0WDQ6

Flash Memory 8 MB

Size (HxWxD) 94x19x69 mm /
3.70x0.75x2.71 in

Weight 63 g / 2.22 oz.

Certifications RED, LVD, EMC, ROHS,
UL, RCM

[more info →](#)



EU
US
ANZ



Shelly Wave Pro 1



Power supply 110-240 V~

Max load EU/ANZ: 16 A (240 V~);
US: 15 A

Connectivity Z-Wave EU: 868.4 MHz
Z-Wave US: 908.4 MHz
Z-Wave ANZ: 919.8 MHz

CPU Z-Wave® S800

Flash Memory 512 kB

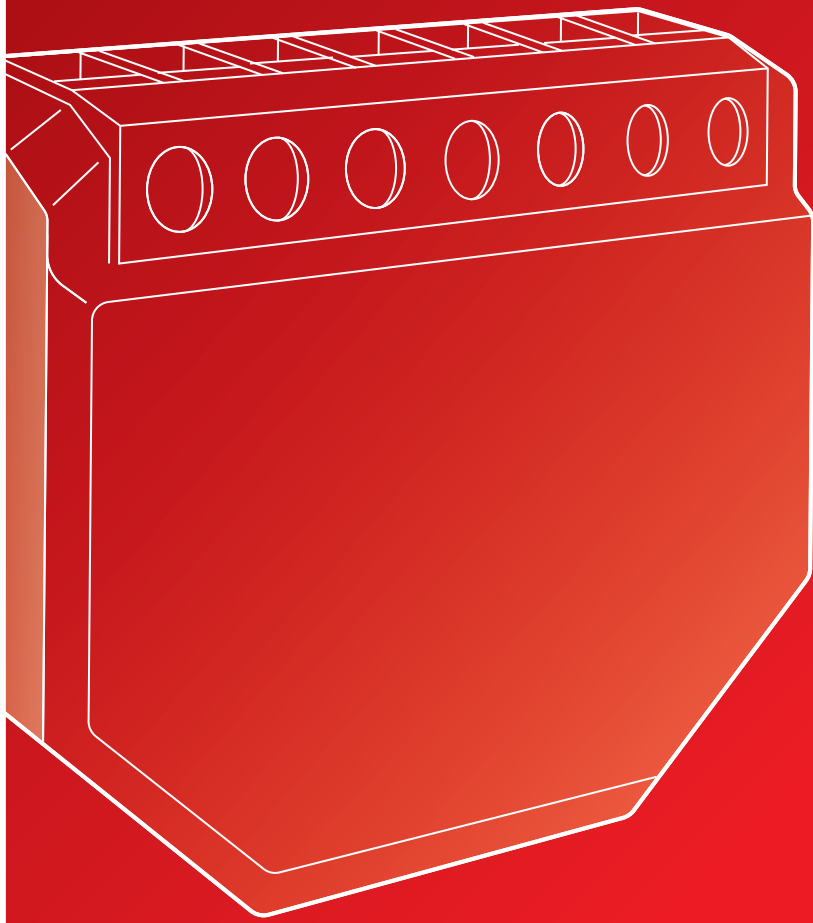
Size (HxWxD) 94x19x69 mm /
3.70x0.75x2.71 in

Weight 60 g / 2.12 oz.

Certifications RED, LVD, EMC, ROHS,
RCM

[more info →](#)





1 channel relays with power metering

TYPICALLY USED FOR



Power monitoring



Lights



Appliances



Floor heating



Water manifolds



GLOBAL



Shelly 1PM Gen3



Power supply 110-240 V~ / 24-30 V==

Max load 16 A (240 V~);
10 A (30 V==)

Connectivity Wi-Fi 4
Bluetooth 4.2

CPU ESP-Shelly-C38F

Flash Memory 8 MB

Size (HxWxD) 37x42x16 mm /
1.46x1.65x0.63 inch

Weight 26 g / 0.92 oz

Certifications RED, LVD, EMC, ROHS



[more info →](#)

GLOBAL



Shelly 1PM Gen4



Power supply 110-240 V~ / 24-30 V==

Max load 16 A (240 V~);
10 A (30 V==)

Connectivity Wi-Fi 6
Bluetooth 5
Zigbee 802.15.4
CPU ESP-Shelly-C68F

Flash Memory 8 MB

Size (HxWxD) 37x42x16 mm /
1.46x1.65x0.63 inch

Weight 26 g / 0.92 oz

Certifications RED, LVD, EMC, ROHS



[more info →](#)

EU

US

ANZ



Shelly Wave 1PM



Power supply EU/US: 110-240 V~ /
24-30 V==; ANZ: 110-240 V~

Max load EU: 16 A (240 V~); 10 A
(30 V==); US: 15 A; 10 A

Connectivity Z-Wave EU: 868.4 MHz
Z-Wave US: 908.4 MHz
Z-Wave ANZ: 919.8 MHz

CPU Z-Wave® S800

Flash Memory 512 kB

Size (HxWxD) 37x42x16 mm /
1.46x1.65x0.63 inch

Weight 26 g / 0.92 oz

Certifications RED, LVD, EMC, ROHS

EU ANZ

US



[more info →](#)



GLOBAL



Shelly 1PM Mini Gen3



Power supply 110-240 V~

Max load 8 A (240 V~)

Connectivity Wi-Fi 4
Bluetooth 4.2

CPU ESP-Shelly-C38F

Flash Memory 8 MB

Size (HxWxD) 29x34x16 mm /
1.34x1.11x0.63 inch

Weight 19 g / 0.65 oz

Certifications RED, LVD, EMC, ROHS

[more info →](#)



GLOBAL



Shelly 1PM Mini Gen4



Power supply 110-240 V~

Max load 8 A (240 V~)

Connectivity Wi-Fi 6
Bluetooth 5
Zigbee 802.15.4
CPU ESP-Shelly-C68F

Flash Memory 8 MB

Size (HxWxD) 29x34x16 mm /
1.34x1.11x0.63 inch

Weight 19 g / 0.65 oz

Certifications RED, LVD, EMC, ROHS

[more info →](#)



EU

US

ANZ



Shelly Wave 1PM Mini



Power supply 110-240 V~

Max load 8 A (240 V~)

Connectivity Z-Wave EU: 868.4 MHz
Z-Wave US: 908.4 MHz
Z-Wave ANZ: 919.8 MHz
CPU Z-Wave® S800

Flash Memory 512 kB

Size (HxWxD) 29x34x16 mm /
1.34x1.11x0.63 inch

Weight 19 g / 0.65 oz

Certifications RED, LVD, EMC, ROHS

[more info →](#)





GLOBAL



Shelly Pro 1PM



Power supply 110-240 V~

Max load 16 A / 15 A UL Version

Connectivity Wi-Fi 4
Bluetooth 4.2
LAN

CPU ESP32-D0WDQ6

Flash Memory 8 MB

Size (HxWxD) 94x19x69 mm /
3.70x0.75x2.71 in

Weight 63 g / 2.22 oz.

Certifications RED, LVD, EMC, ROHS,
UL, RCM

[more info →](#)



EU
US
ANZ



Shelly Wave Pro 1PM



Power supply 110-240 V~

Max load EU/ANZ: 16 A (240 V~);
US: 15 A

Connectivity Z-Wave EU: 868.4 MHz
Z-Wave US: 908.4 MHz
Z-Wave ANZ: 919.8 MHz

CPU Z-Wave® S800

Flash Memory 512 kB

Size (HxWxD) 94x19x69 mm /
3.70x0.75x2.71 in

Weight 60 g / 2.12 oz.

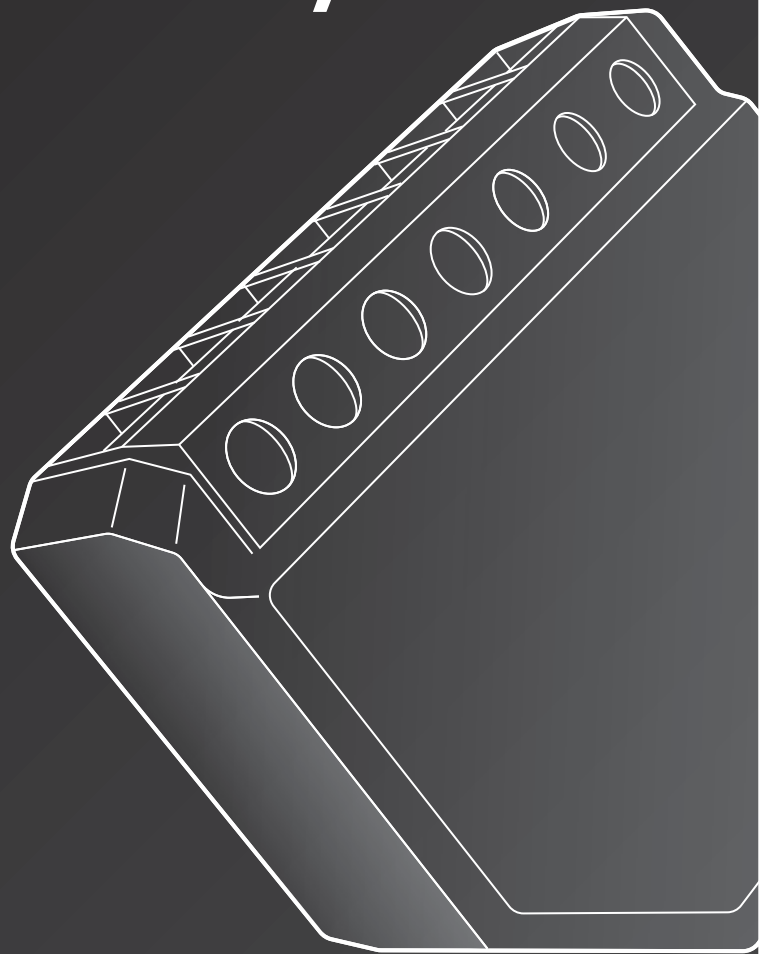
Certifications RED, LVD, EMC, ROHS,
RCM

[more info →](#)





2 channel relays



TYPICALLY USED FOR



Power monitoring



Cover & Blinds



Lights



Appliances



Irrigation



Floor heating



GLOBAL



Shelly 2PM Gen3



Power supply 110-240 V~ / 24 V=

Max load 16 A (240 V~);
10 A (30 V=)

Power metering Yes

Connectivity Wi-Fi 4
Bluetooth 4.2

CPU ESP-Shelly-C38F

Flash Memory 8 MB

Size (HxWxD) 37x42x16 mm /
1.46x1.65x0.63 in

Weight 30 g / 1.06 oz

Certifications RED, LVD, EMC, ROHS, RCM



[more info →](#)

EU

US

ANZ



Shelly Wave 2PM



Power supply EU: 110-240 V~ / 24 V=
ANZ: 110-240 V ~
US: 120 V~

Max load EU/ANZ: 10 A per channel,
16 A total (240 V~)
EU: 10 A (30 V=)
US: 7 A per channel,
14 A total (120 V~)

Power metering Yes

Connectivity Z-Wave EU: 868.4 MHz
Z-Wave US: 908.4 MHz
Z-Wave ANZ: 919.8 MHz
Z-Wave® S800

CPU

Flash Memory 512 kB

Size (HxWxD) 37x42x16 mm /
1.46x1.65x0.63 in

Weight 29 g / 1,02 in

Certifications RED, LVD, EMC, ROHS, RCM

EU ANZ US



[more info →](#)

EU

US

ANZ



Shelly Wave Shutter



Power supply EU: 110-240 V~
ANZ: 110-240 V ~
US: 120 V~

Max load EU/ANZ: 10 A per channel,
(240 V~)
US: 7 A per channel,
(120 V~)

Power metering Yes

Connectivity Z-Wave EU: 868.4 MHz
Z-Wave US: 908.4 MHz
Z-Wave ANZ: 919.8 MHz
Z-Wave® S800

CPU

Flash Memory 512 kB

Size (HxWxD) 37x42x16 mm /
1.46x1.65x0.63 in

Weight 29 g / 1,02 in

Certifications RED, LVD, EMC, ROHS, RCM

EU ANZ US



[more info →](#)



GLOBAL



Shelly
Pro 2PM



Power supply 110-240 V~

Max load 16 A per channel,
25 A total /
12.5 A UL Version

Power metering **Yes**

Connectivity **Wi-Fi 4**
Bluetooth 4.2
LAN

CPU **ESP32-D0WDQ6**

Flash Memory **8 MB**

Size (HxWxD) **94x19x69 mm /**
3.70x0.75x2.71 in

Weight **76 g / 2.68 oz**

Certifications **RED, LVD, EMC, ROHS,**
UL, RCM



[more info →](#)

EU

US

ANZ



Shelly
Wave Pro 2PM



Power supply 110-240 V~

Max load EU/ANZ: 16 A per channel,
25 A total;
US: 12.5 A per channel,
25 A total;

Power metering **Yes**

Connectivity **Z-Wave EU: 868.4 MHz**
Z-Wave US: 908.4 MHz
Z-Wave ANZ: 919.8 MHz

CPU **Z-Wave® S800**

Flash Memory **512 kB**

Size (HxWxD) **94x19x69 mm /**
3.70x0.75x2.71 in

Weight **73 g / 2.58 oz.**

Certifications **RED, LVD, EMC, ROHS,**
RCM



[more info →](#)



GLOBAL

Shelly Pro 2



Power supply 110-240 V~

Max load 16 A / 12.5 A ULVersion

Power metering No

Connectivity Wi-Fi 4
Bluetooth 4.2
LAN

CPU ESP32-D0WDQ6

Flash Memory 8 MB

Size (HxWxD) 94x19x69 mm /
3.70x0.75x2.71 in

Weight 76 g / 2.68 oz

Certifications RED, LVD, EMC, ROHS,
UL, RCM



[more info →](#)



EU
US
ANZ

Shelly Wave Pro 2



Power supply 110-240 V~

Max load EU/ANZ: 16 A per channel,
25 A total;
US: 12.5 A per channel,
25 A total;

Power metering No

Connectivity Z-Wave EU: 868.4 MHz
Z-Wave US: 908.4 MHz
Z-Wave ANZ: 919.8 MHz

CPU Z-Wave® S800

Flash Memory 512 kB

Size (HxWxD) 94x19x69 mm /
3.70x0.75x2.71 in

Weight 73 g / 2.58 oz.

Certifications RED, LVD, EMC, ROHS,
RCM



[more info →](#)



3+ channel relays

TYPICALLY USED FOR



Load shedding



Lights



Appliances



Valves



Heating & Cooling



GLOBAL



Shelly Pro 3



Power supply 110-240 V~

Max load 16 A per channel, 48 A total

Connectivity Wi-Fi 4
Bluetooth 4.2
LAN

CPU ESP32-D0WDQ6

Flash Memory 8 MB

Size (HxWxD) 96x53x59 mm /
3.78x2.01x2.32 inch

Weight

Certifications RED, LVD, EMC, ROHS, RCM



more info →

EU
US
ANZ



Shelly Wave Pro 3



Power supply 110-240 V~

Max load 16 A per channel, 48 A total

Connectivity Z-Wave EU: 868.4 MHz
Z-Wave US: 908.4 MHz
Z-Wave ANZ: 919.8 MHz

CPU Z-Wave® S800

Flash Memory 512 kB

Size (HxWxD) 96x53x59 mm /
3.78x2.01x2.32 inch

Weight 150 g / 5.29 oz

Certifications RED, LVD, EMC, ROHS, RCM



more info →



GLOBAL



Shelly Pro 4PM



Power supply 110-240 V~

Max load 16 A per channel, 40 A total

Connectivity Wi-Fi 4
Bluetooth 4.2
LAN

CPU ESP32-D0WDQ6

Flash Memory 8 MB

Size (HxWxD) 96x53x59 mm /
3.78x2.01x2.32 inch

Weight

Certifications RED, LVD, EMC, ROHS, RCM

more info →



GLOBAL



Shelly Pro Dual Cover/ Shutter PM



Power supply 110-240 V~

Max load 16 A per channel, 32 A total

Connectivity Wi-Fi 4
Bluetooth 4.2
LAN

CPU ESP32-D0WDQ6

Flash Memory 8 MB

Size (HxWxD) 96x53x59 mm /
3.78x2.01x2.32 inch

Weight

Certifications RED, LVD, EMC, ROHS

more info →



TYPICALLY USED FOR



Energy monitoring



Energy saving



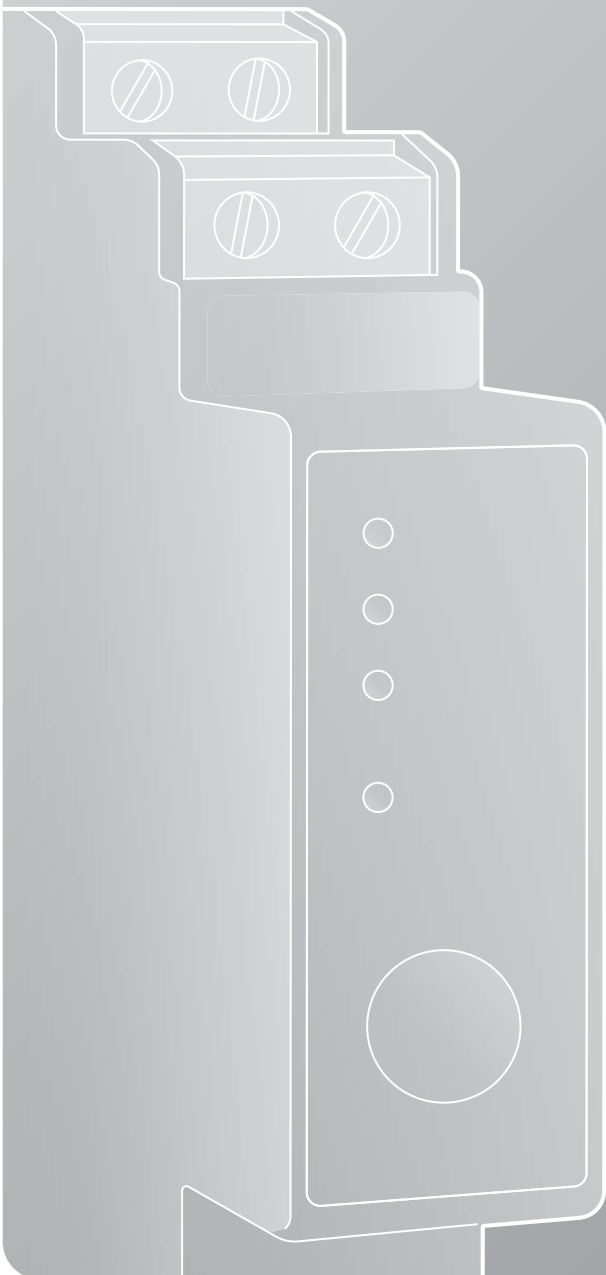
Electric chargers

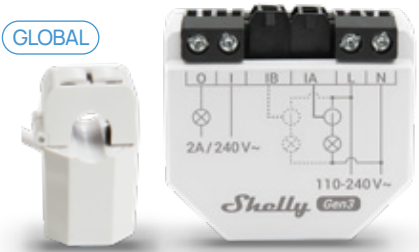


Photo voltaic



Energy meters





Shelly EM Gen3



Power supply 110-240 V~

Max load 2 A (240 V~)

Internal data storage Up to 10 days of 1 min data records

Power metering Yes

Connectivity Wi-Fi 4
Bluetooth 4.2

CPU ESP-Shelly-C38F

Flash Memory 8 MB

Size (HxWxD) 37x42x16 mm /
1.46x1.65x0.63 inch

Weight EM Gen3 - 23 g / 0.81 oz

Certifications RED, LVD, EMC, ROHS

[more info →](#)



Shelly 3EM-63T Gen3



Power supply 220-240 V~

Ammeters 0 - 63 A (130 A saturation)

Internal data storage Up to 7 days

Power metering Yes

Connectivity Wi-Fi 4
Bluetooth 4.2

CPU ESP-Shelly-C38F

Flash Memory 8 MB

Size (HxWxD) 31x54x42 mm /
1.22x2.13x1.65 in

Weight 52 g / 1.83 oz

Certifications RED, LVD, EMC, ROHS

[more info →](#)



Shelly 3EM-63W Gen3



Power supply 220-240 V~

Ammeters 0 - 63 A (130 A saturation)

Internal data storage Up to 7 days

Power metering Yes

Connectivity Wi-Fi 4
Bluetooth 4.2

CPU ESP-Shelly-C38F

Flash Memory 8 MB

Size (HxWxD) 21x54x42 mm /
0.83x2.13x1.65 inch

Weight 58 g / 2.05 oz

Certifications RED, LVD, EMC, ROHS

[more info →](#)





GLOBAL



Shelly PM Mini Gen3



Power supply 110-240 V~

Max load 16 A (240 V~)

Power metering **Yes**Connectivity **Wi-Fi 4**
Bluetooth 4.2CPU **ESP-Shelly-C38F**Flash Memory **8 MB**Size (HxWxD) **29x34x16 mm /**
1.34x1.11x0.63 inchWeight **19 g / 0.65 oz**Certifications **RED, LVD, EMC, ROHS**[more info →](#)

GLOBAL



Shelly EM Mini Gen4



Power supply 110-240 V~

Max load 16 A (240 V~)

Power metering **Yes**Connectivity **Wi-Fi 6**
Bluetooth 5
Zigbee 802.15.4
CPU **ESP-Shelly-C68F**Flash Memory **8 MB**Size (HxWxD) **29x34x16 mm /**
1.34x1.11x0.63 inchWeight **19 g / 0.65 oz**Certifications **RED, LVD, EMC, ROHS**[more info →](#)

EU

US

ANZ



Shelly Wave PM Mini



Power supply 110-240 V~

Max load 16 A (240 V~)

Power metering **Yes**Connectivity **Z-Wave EU: 868.4 MHz**
Z-Wave US: 908.4 MHz
Z-Wave ANZ: 919.8 MHzCPU **Z-Wave® S800**Flash Memory **512 kB**Size (HxWxD) **29x34x16 mm /**
1.34x1.11x0.63 inchWeight **19 g / 0.65 oz**Certifications **RED, LVD, EMC, ROHS**[more info →](#)



GLOBAL



Shelly Pro EM-50



Power supply 100 - 260 V~

Ammeters 0 - 50 A
(RMS via CT)

Power metering **Yes**

Connectivity **Wi-Fi 4**
Bluetooth 4.2
LAN

CPU **ESP32-D0WDQ6**

Flash Memory **16 MB**

Size (HxWxD) **94x19x69 mm /**
3.70x0.75x2.71 in

Weight **63 g / 2.22 oz**

Certifications **RED, LVD, EMC, ROHS,**
RCM

[more info →](#)

GLOBAL



Shelly Pro 3EM-120



Power supply 100 - 260 V~

Ammeters 0 - 120 A
(RMS via CT)

Power metering **Yes**

Connectivity **Wi-Fi 4**
Bluetooth 4.2
LAN

CPU **ESP32-D0WDQ6**

Flash Memory **16 MB**

Size (HxWxD) **94x19x69 mm /**
3.70x0.75x2.71 in

Weight **62 g / 2.19 oz**

Certifications **RED, LVD, EMC, ROHS,**
RCM

[more info →](#)

GLOBAL



Shelly Pro 3EM-400



Power supply 100 - 260 V~

Ammeters 0 - 400 A
(RMS via CT)

Power metering **Yes**

Connectivity **Wi-Fi 4**
Bluetooth 4.2
LAN

CPU **ESP32-D0WDQ6**

Flash Memory **16 MB**

Size (HxWxD) **94x19x69 mm /**
3.70x0.75x2.71 in

Weight **62 g / 2.19 oz**

Certifications **RED, LVD, EMC, ROHS,**
RCM

[more info →](#)



GLOBAL

Shelly Pro 3EM 3CT 63



Power supply 100 - 260 V~

Ammeters 0 - 63 A
(RMS via CT)

Power metering **Yes**

Connectivity **Wi-Fi 4**
Bluetooth 4.2
LAN

CPU **ESP32-D0WDQ6**

Flash Memory **16 MB**

Size (HxWxD) **94x19x69 mm /**
3.70x0.75x2.71 in

Weight **62 g / 2.19 oz**

Certifications **RED, LVD, EMC, ROHS,**
RCM

[more info →](#)

GLOBAL



Shelly Pro 3EM Switch Add-on

Power supply **3.3V --- and 12V --- (from**
Shelly Pro 3EM device)

Ammeters -

Power metering **No**

Max switching **240 V~/30 V ---**
voltage

Max switching **2 A**
current

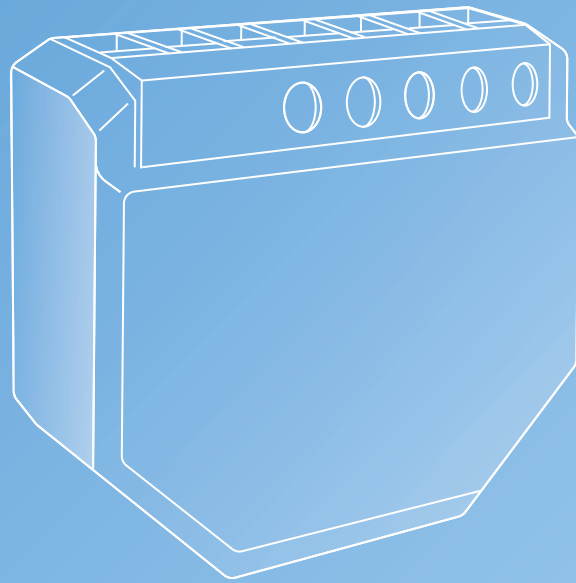
Flash Memory -

Size (HxWxD) **94x19x69 mm /**
3.70x0.75x2.71 in

Weight **20 g / 0.70 oz**

Certifications **LVD, EMC, ROHS, RCM**

[more info →](#)



Lighting control for no neutral installations

TYPICALLY USED FOR



Lights



No neutral Instalation



EU



Shelly 1L Gen3



Power supply 220-240 V~ 50Hz (Shelly Bypass is required)

Max. switching power 200W

Connectivity Wi-Fi 4
Bluetooth 4.2

CPU ESP-Shelly-C38F

Flash Memory 8 MB

Size (HxWxD) 37x42x16 mm /
1.46x1.65x0.63 inch

Weight 24 g / 0.85 oz

Certifications RED, LVD, EMC, ROHS



[more info →](#)

EU



Shelly 2L Gen3



Power supply 220-240 V~ 50Hz (Shelly Bypass is required)

Max. switching power 200W through O1
700W through O2

Connectivity Wi-Fi 4
Bluetooth 4.2

CPU ESP-Shelly-C38F

Flash Memory 8 MB

Size (HxWxD) 37x42x16 mm /
1.46x1.65x0.63 inch

Weight 24 g / 0.85 oz

Certifications RED, LVD, EMC, ROHS



[more info →](#)



Dimmers



TYPICALLY USED FOR



LED strips



Lights



Dimming



EU

ANZ



Shelly Dimmer Gen3

Compatible with no neutral installation

- Power supply 220-240 V~ (Shelly Bypass is required)
- Ammeter range (AC) 0 A - 3 A, ± 5 % (when used with neutral)
- Dimming type Trailing edge
- Connectivity Wi-Fi 4
Bluetooth 4.2
- CPU ESP32 C3 / STM32 G051
- Flash Memory 8 MB
- Size (HxWxD) 38x42.5x16.5 mm / 1.50x1.67x0.65 inch
- Weight 24.3 g / 0.86 oz
- Certifications RED, LVD, EMC, ROHS, RCM



[more info →](#)

GLOBAL



Shelly DALI Dimmer Gen3

- Power supply 110-240 V~
- Max load Bus power supply guaranteed 10mA (up to 5 DALI control gear units), Short circuit current < 35 mA
- Connectivity Wi-Fi 4
Bluetooth 4.2
- CPU ESP32-C3 Shelly
- Flash Memory 8 MB
- Size (HxWxD) 38x42.5x16.5 mm / 1.50x1.67x0.65 inch
- Weight 18 g / 0.63 oz
- Certifications RED, LVD, EMC, ROHS, RCM, DALI-2



[more info →](#)

GLOBAL



Shelly Pro Dimmer 1PM

- Power supply 110-240 V~
- Max load 200 W
- Connectivity Wi-Fi 4
Bluetooth 4.2
LAN
- CPU ESP32-D0WDQ6
- Flash Memory 8 MB
- Size (HxWxD) 94x19x69 mm / 3.70x0.75x2.71 in
- Weight 75 g / 2.7 oz
- Certifications LVD, RED, EMC, ROHS, RCM



[more info →](#)



EU
US
ANZ



Shelly
Wave PRO Dimmer 1PM



Power supply **110-240 V~**

Max load **200 W**

Connectivity **Z-Wave EU: 868.4 MHz
Z-Wave US: 908.4 MHz
Z-Wave ANZ: 919.8 MHz**

CPU **Z-Wave® S800**

Flash Memory **512 kB**

Size (HxWxD) **94x19x69 mm /
3.70x0.75x2.71 in**

Weight **75 g / 2.7 oz**

Certifications **LVD, RED, EMC, ROHS**



[more info →](#)

GLOBAL



Shelly
Pro Dimmer 2PM



Power supply **110-240 V~**

Max load **200 W per channel**

Connectivity **Wi-Fi 4
Bluetooth 4.2
LAN**

CPU **ESP32-D0W0Q6**

Flash Memory **8 MB**

Size (HxWxD) **94x19x69 mm /
3.70x0.75x2.71 in**

Weight **75 g / 2.7 oz**

Certifications **LVD, RED, EMC, ROHS, RCM**



[more info →](#)

EU
US
ANZ



Shelly
Wave PRO Dimmer 2PM



Power supply **110-240 V~**

Max load **200 W per channel**

Connectivity **Z-Wave EU: 868.4 MHz
Z-Wave US: 908.4 MHz
Z-Wave ANZ: 919.8 MHz**

CPU **Z-Wave® S800**

Flash Memory **512 kB**

Size (HxWxD) **94x19x69 mm /
3.70x0.75x2.71 in**

Weight **75 g / 2.7 oz**

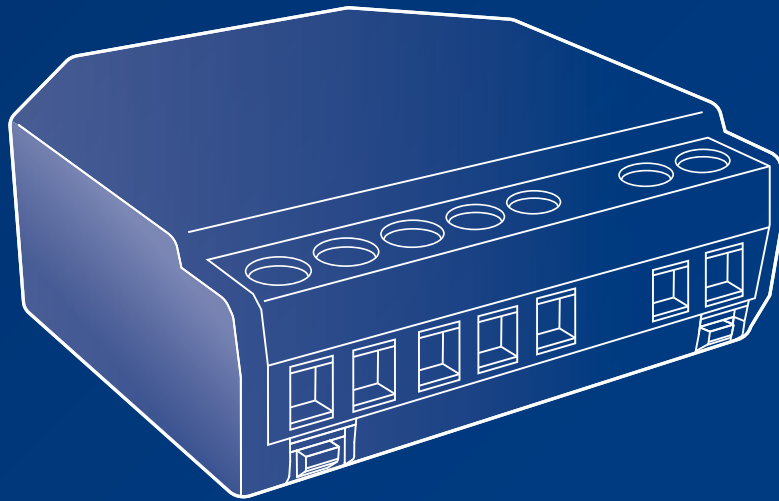
Certifications **RED, LVD, EMC, ROHS,
RCM**



[more info →](#)



0/1-10V Controllers



TYPICALLY USED FOR



LED strips



Lights



Dimming



Power monitoring



GLOBAL



Shelly
**Dimmer 0/1-10V PM
Gen3**



Power supply 110-240 V~

Max load 13 A (240 V~)

Connectivity Wi-Fi 4
Bluetooth 4.2

CPU Shelly ESP32 C3

Flash Memory 8 MB

Size (HxWxD) 38.5x43.5x17mm /
1.52x1.71x0.67in

Weight 28.5 g / 0.99 oz

Certifications RED, LVD, EMC, ROHS, RCM



more info →

GLOBAL



Shelly
Pro Dimmer 0/1-10V PM



Power supply 110-240 V~

Max load 16 A (240 V~)

Connectivity Wi-Fi 4
Bluetooth 4.2
LAN

CPU ESP32-D0WDQ6

Flash Memory 8 MB

Size (HxWxD) 94x19x69 mm /
3.70x0.75x2.71 in

Weight 70 g / 2.5 oz

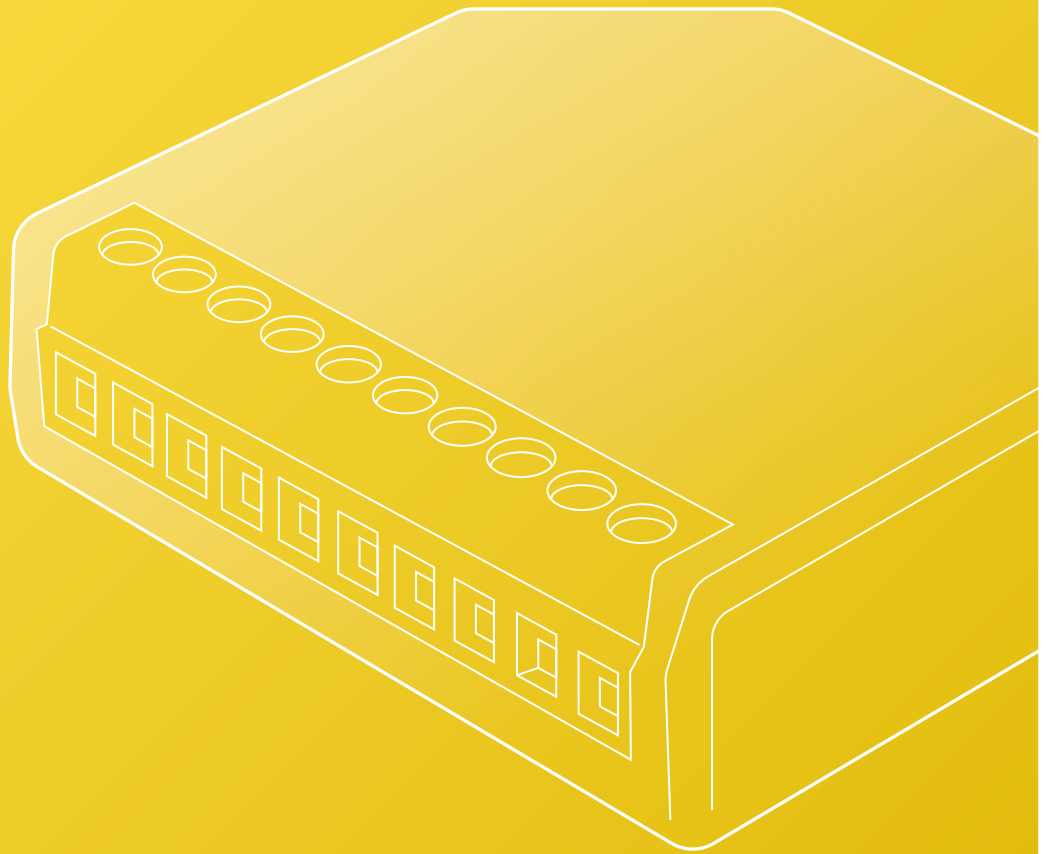
Certifications RED, LVD, EMC, ROHS, RCM



more info →



RGBW / RGBWW Controllers



TYPICALLY USED FOR



LED strips



Lights



Dimming



Colour



Power monitoring



GLOBAL



Shelly
Plus RGBW PM



Power supply 12-24 V $\overline{\text{=}}$

Max load 4 A per channel (10 A total)

Connectivity Wi-Fi 4
Bluetooth 4.2

CPU ESP-Shelly-C38F

Flash Memory 4 MB

Size (HxWxD) 42x37x12 mm /
1.65x1.46x0.66 inch

Weight 17 g / 0.60 oz

Certifications RED, EMC, ROHS, RCM



more info →

GLOBAL



Shelly
PRO RGBWW PM



Power supply 12-24 V $\overline{\text{=}}$

Max load 6 A per channel (16 A total)

Connectivity Wi-Fi 4
Bluetooth 4.2
LAN

CPU ESP32-D0WDQ6

Flash Memory 8 MB

Size (HxWxD) 94x19x69 mm /
3.70x0.75x2.71 inch

Weight 61 g / 2.15 oz

Certifications RED, EMC, ROHS



more info →

TYPICALLY USED FOR



Lights



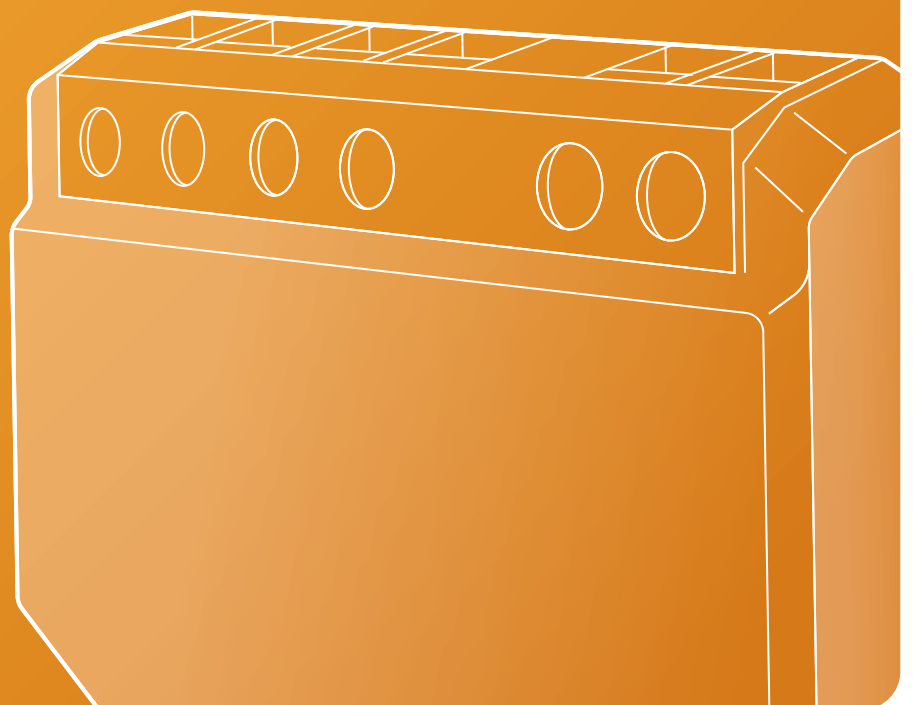
Appliances



Scene activation



Input Controllers





Shelly
Plus i4



Power supply 110-240 V~

Max load -

Connectivity **Wi-Fi 4**
Bluetooth 4.2

CPU **ESP32-U4WDH**

Flash Memory **4 MB**

Size (HxWxD) **37x42x16 mm /**
1.46x1.65x0.63 in

Weight **18 g / 0.63 oz**

Certifications **LVD, RED, EMC, ROHS, RCM**

[more info →](#)



Shelly
i4 Gen3



Power supply 110-240 V~

Max load -

Connectivity **Wi-Fi 4**
Bluetooth 4.2

CPU **ESP-Shelly-C38F**

Flash Memory **8 MB**

Size (HxWxD) **37x42x16 mm /**
1.46x1.65x0.63 in

Weight **19 g / 0.67 oz**

Certifications **LVD, RED, EMC, ROHS, RCM**

[more info →](#)



Shelly
Wave i4



Power supply 110-240 V~

Max load -

Connectivity **Z-Wave EU: 868.4 MHz**
Z-Wave US: 908.4 MHz
Z-Wave ANZ: 919.8 MHz

CPU **Z-Wave® S800**

Flash Memory **512 kB**

Size (HxWxD) **37x42x16 mm /**
1.46x1.65x0.63 in

Weight **17 g / 0.6 oz**

Certifications **RED, LVD, EMC, ROHS**

[more info →](#)





GLOBAL



Shelly Plus i4 DC



Power supply 5-24 V $\overline{\text{DC}}$

Max load -

Connectivity Wi-Fi 4
Bluetooth 4.2

CPU ESP32-U4WDH

Flash Memory 4 MB

Size (HxWxD) 37x42x16 mm /
1.46x1.65x0.63 in

Weight 17 g / 0.6 oz

Certifications LVD, RED, EMC, ROHS



[more info →](#)

EU

US

ANZ



Shelly Wave i4 DC



Power supply 5-24 V $\overline{\text{DC}}$

Max load -

Connectivity Z-Wave EU: 868.4 MHz
Z-Wave US: 908.4 MHz
Z-Wave ANZ: 919.8 MHz

CPU Z-Wave[®] S800

Flash Memory 512 kB

Size (HxWxD) 37x42x16 mm /
1.46x1.65x0.63 in

Weight 17 g / 0.6 oz

Certifications LVD, RED, EMC, ROHS



[more info →](#)



Control Panels

TYPICALLY USED FOR



Room management



Centralized control



Thermostat



EU

ANZ



Shelly
Wall Display



Power supply **230 V~**

Max load **5 A**

Connectivity **Wi-Fi 4**
Bluetooth 4.2

CPU **MTK6580**

Flash Memory **4 GB**

Size (HxWxD) **85x85x30 mm /**
3.35x3.35x1.18 inch

Weight **180 g / 6.35 oz**

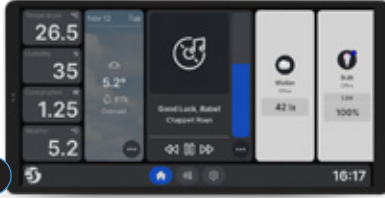
Display **4 inch color display**

Certifications **RED, LVD, EMC, ROHS, RCM**



[more info →](#)

EU



Shelly
Wall Display x2



Power supply **230 V~ / USB Type-C**
power supply 5 V=

Max load **5 A**

Connectivity **Wi-Fi 4**
Bluetooth 5

CPU **SC7731E, Quad Core A7**
1.3 GHz

Flash Memory **4 GB**

Size (HxWxD) **87x178x33 mm /**
3.43x7x1.3 inch

Weight **256 g / 9.03 oz**

Display **6.95 inch color display**

Certifications **RED, LVD, EMC, ROHS**



[more info →](#)



Plug&Play



TYPICALLY USED FOR



Appliances



Heating & Cooling



Lights



Energy saving



Power monitoring

PLUGS FOR INDOORS



PLUGS FOR OUTDOORS



EU



Shelly Plug S MTR Gen3



Power supply **220 - 230 V~**

Max load **12 A**

Socket type **Type F / Schuko**

Connectivity **Wi-Fi 4
Bluetooth 4.2**

CPU **ESP-Shelly-C38F**

Flash Memory **8 MB**

Size (HxWxD) **56x56x103 mm /
2.21x2.21x4.55 in**

Weight **85 g / 3 oz**

Certifications **LVD, RED, EMC, ROHS**



[more info →](#)

EU



Shelly Wave Plug S



Power supply **220 - 230 V~**

Max load **12 A**

Socket type **Type F / Schuko**

Connectivity **Z-Wave EU: 868.4 MHz**

CPU **Z-Wave® S800**

Flash Memory **512 kB**

Size (HxWxD) **44x44x70 mm /
1.73x1.73x2.75 in**

Weight **60 g / 2.08 oz**

Certifications **LVD, RED, EMC, ROHS**



[more info →](#)

EU



Shelly Outdoor Plug S Gen3



Power supply **230 V~**

Max load **12 A**

Socket type **Type F / Schuko**

Connectivity **Wi-Fi 4
Bluetooth 4.2**

CPU **ESP-Shelly-C38F**

Flash Memory **8 MB**

Size (HxWxD) **56x56x103 mm /
2.21x2.21x4.55 in**

Weight **85 g / 3 oz**

Certifications **RED, LVD, EMC, ROHS**



[more info →](#)



UK



Shelly
Plus Plug UK



Power supply **230 V~**
 Max load **13 A**
 Socket type **Type G / BS 1363**
 Connectivity **Wi-Fi 4**
Bluetooth 4.2
 CPU **ESP32-U4WDH**
 Flash Memory **4 MB**
 Size (HxWxD) **60x60x56 mm /**
2.36x2.36x2.20 in
 Weight **74 g / 2.6 oz**
 Certifications **LVD, RED**



[more info →](#)

UK



Shelly
Wave Plug UK



Power supply **230 V~**
 Max load **13 A**
 Socket type **Type G / BS 1363**
 Connectivity **Z-Wave EU: 868.4 MHz**
 CPU **Z-Wave® S800**
 Flash Memory **512 kB**
 Size (HxWxD) **60x60x56 mm /**
2.36x2.36x2.20 in
 Weight **74 g / 2.6 oz**
 Certifications **LVD, RED, EMC, ROHS**



[more info →](#)



US



Shelly
Plus Plug US



Power supply **120 V~**
 Max load **15 A**
 Socket type **Type B / NEMA 5-15**
 Connectivity **Wi-Fi 4**
Bluetooth 4.2
 CPU **ESP32**
 Flash Memory **4 MB**
 Size (HxWxD) **38x84x52 mm /**
1.5x3.3x2.0 in
 Weight **70 g / 2.47 oz**
 Certifications **FCC, ETL**



more info →

US



Shelly
Wave Plug US



Power supply **120 V~**
 Max load **15 A**
 Socket type **Type B / NEMA 5-15**
 Connectivity **Z-Wave US: 908,4 MHz**
 CPU **Z-Wave® S800**
 Flash Memory **512 kB**
 Size (HxWxD) **38x84x52 mm /**
1.5x3.3x2.0 in
 Weight **70 g / 2.47 oz**
 Certifications **FCC, ETL**



more info →



EU



Shelly
DUO E27/GU10



	E27	GU10
Power supply	100-240 V~	
Power rating	9W	5W
Socket type	E27	GU10
Connectivity	Wi-Fi 4	Wi-Fi 4
Beam angle	180°	120°
Color temperature	2700 K – 6500 K	
Brightness	Up to 800 lm	Up to 400 lm
Lifetime	30000 hours	
Size (WxH)	60x122 mm / 50x73 mm / 2.36x4.08 in 1.96x2.87 in	
Certifications	RED, LVD, EMC, ROHS	

more info →



EU



Shelly
DUO RGBW E27/GU10



	E27	GU10
Power supply	100-240 V~	
Power rating	9W	5W
Socket type	E27	GU10
Connectivity	Wi-Fi 4	Wi-Fi 4
Beam angle	180°	120°
Color temperature	RGB + Natural white (4000 K)	
Brightness	Up to 800 lm	Up to 400 lm
Lifetime	30000 hours	
Size (WxH)	60x122 mm / 50x73 mm / 2.36x4.08 in 1.96x2.87 in	
Certifications	RED, LVD, EMC, ROHS	

more info →





EU



Shelly
Vintage A60



Power supply **230 V~**
 Power rating **7 W**
 Socket type **E27**
 Connectivity **Wi-Fi 4**
 Beam angle **360°**
 Color temperature **2700 K (Warm white)**
 Brightness **750 Lm**
 Lifetime **15000 hours**
 Size (WxH) **60x117 mm / 2.36x4.52 in**
 Certifications **RED, LVD, EMC, ROHS**



[more info →](#)

EU



Shelly
Vintage ST64



Power supply **230 V~**
 Power rating **7 W**
 Socket type **E27**
 Connectivity **Wi-Fi 4**
 Beam angle **360°**
 Color temperature **2700 K (Warm white)**
 Brightness **750 Lm**
 Lifetime **15000 hours**
 Size (WxH) **64x160 mm / 2.51x6.29 in**
 Certifications **RED, LVD, EMC, ROHS**



[more info →](#)

EU



Shelly
Vintage G125



Power supply **230 V~**
 Power rating **4 W**
 Socket type **E27**
 Connectivity **Wi-Fi 4**
 Beam angle **360°**
 Color temperature **2700 K (Warm white)**
 Brightness **260 Lm**
 Lifetime **15000 hours**
 Size (WxH) **125x155 mm / 4.92x6.10 in**
 Certifications **RED, LVD, EMC, ROHS**



[more info →](#)



Sensors & Remote Control

TYPICALLY USED FOR



Room management



Heating & Cooling



Motion detection



Leak & Gas detection



Shelly
BLU TRV



- Power supply **2x AA, 1.5 V batteries**
- Battery life **Up to 2 years (depending on usage)**
- Mounting **M30x1.5
6 adapters included**
- Connectivity **Bluetooth 4.2**
- Size (HxD): **78 x Ø54 mm /
3.07xØ2.13 in**
- Weight **107 g / 3.77 oz**
- Certifications **LVD, RED, EMC, ROHS**



more info →



Shelly
H&T Gen3



- Power supply **4x AA, 1.5 V batteries**
- Battery life **Up to 1 year (depending on usage)**
- Mounting **Stand alone
Wall mounting**
- Connectivity **W-Fi 4
Bluetooth 4.2**
- Size (HxWxD) **70x70x26 mm /
2.76x2.76x1.02 inch (without stand)**
- Weight **47 g / 1.66 oz**
- Certifications **LVD, RED, EMC, ROHS**



more info →



Shelly
BLU H&T



- Power supply **1x 3 V CR2032 battery**
- Battery life **3 years**
- Mounting **On a flat surface**
- Connectivity **Bluetooth 4.2**
- Size (HxWxD) **37x37x10 mm /
1.46x1.46x0.39 in**
- Weight **13 g / 0.44 oz**
- Certifications **LVD, RED, EMC, ROHS**



more info →



GLOBAL



Shelly
BLU Door/Window



Power supply 1x 3 V CR2032 battery

Battery life Up to 5 years

Mounting Glued to door or window

Connectivity Bluetooth 4.2

Size (HxWxD) 35x35x7 mm / 1.38x1.38x0.27 in (Sensor unit)
35x12x7 / 1.44x0.47x0.27 in (Magnet)

Weight 10 g / 0.35 oz - Device
8 g / 0.28 oz - Magnet

Certifications LVD, RED, EMC, ROHS



more info →

EU



Shelly
Wave Door/Window



Power supply 1x 3 V CR2032 battery

Battery life Up to 2 years

Mounting Glued to door or window

Connectivity Z-Wave EU: 868.4 MHz

Size (HxWxD) 35x35x7 mm / 1.38x1.38x0.27 in (Sensor unit)
35x12x7 / 1.44x0.47x0.27 in (Magnet)

Weight 10 g / 0.35 oz - Device
8 g / 0.28 oz - Magnet

Certifications LVD, RED, EMC, ROHS



more info →

GLOBAL



Shelly
BLU Motion



Power supply 1x 3 V CR2477 battery

Battery life Up to 5 years

Mounting Glued

Connectivity Bluetooth 4.2

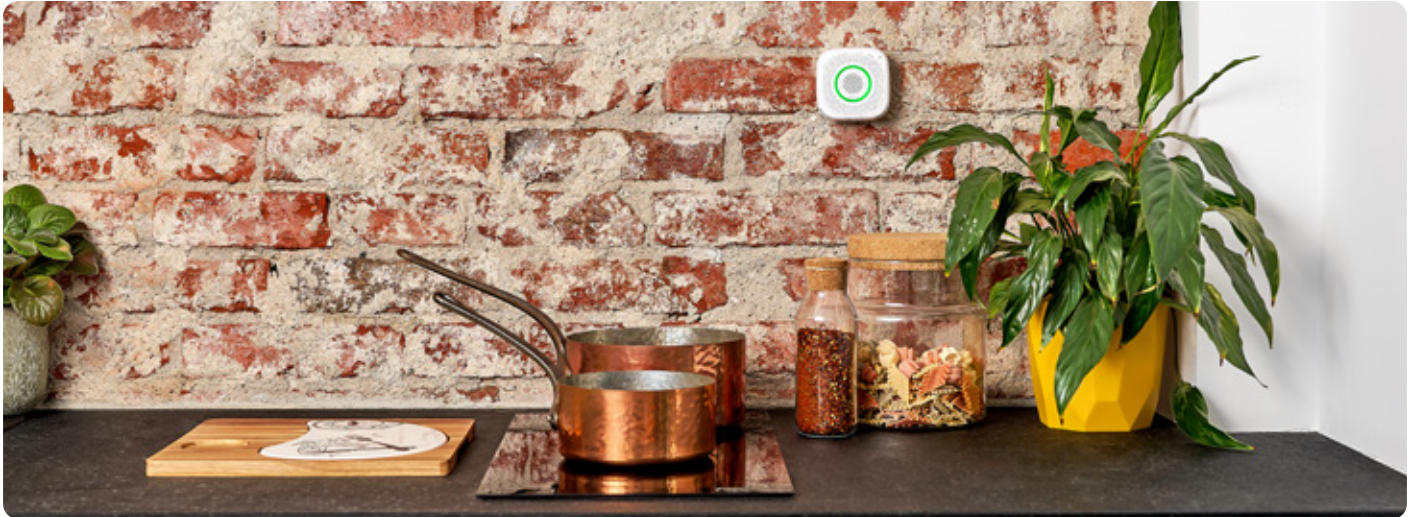
Size (HxWxD) 32x42x27 mm / 1.26x1.65x1.06 in

Weight 26 g / 0.92 oz (Device with the battery)

Certifications LVD, RED, EMC, ROHS



more info →



GLOBAL



Shelly
Flood



Power supply 1 x CR123A – 3V batteries

Battery life Up to 18 months

Connectivity W-Fi 4

Size (HxWxD) 70x70x19 mm /
2.75x2.75x0.74 in

Certifications LVD, RED, EMC, ROHS



more info →

GLOBAL



Shelly
Plus Smoke



Power supply 1 x CR123A – 3V batteries

Battery life 3 year

Connectivity W-Fi 4
Bluetooth 4.2

Size (HxWxD) 86x86x31mm /
3.39x3.39x1.22 in

Certifications LVD, RED, EMC, ROHS



more info →

GLOBAL



Shelly
GAS



Power supply 110-230 V~

Alarm indicator LED Flash & Sound

Connectivity W-Fi 4

Size (HxWxD) 89,5x89,5x38 mm /
3.52x3.52x1.49 in

Certifications LVD, RED, EMC, ROHS



more info →



GLOBAL



Shelly
BLU Button Tough1



Power supply **1 x CR2032 – 3V batteries**

Battery life **up to 2 years**

Connectivity **Bluetooth 4.2**

Size (HxWxD) **42x42x13 mm /
1.65x1.65x0.51 in**

Weight **15 g / 0.53 oz**

Certifications **LVD, RED, EMC, ROHS**

[more info →](#)



EU



Shelly
BLU RC Button 4



Power supply **1 x CR2032 – 3V batteries**

Battery life **Up to 2 years**

Connectivity **Bluetooth 4.2**

Size (HxWxD) **Button: 65x30x13 mm /
2.56x1.18x0.51 in
Magnetic holder (for flat
surfaces): 83x44x9 mm /
3.27x1.73x0.35 in**

Weight **21 g / 0.74 oz**

Certifications **LVD, RED, EMC, ROHS**

[more info →](#)



US



Shelly
BLU RC Button 4 US



Power supply **1 x CR2032 – 3V batteries**

Battery life **Up to 2 years**

Connectivity **Bluetooth 4.2**

Size (HxWxD) **Button: 65x30x13 mm /
2.56x1.18x0.51 in
Magnetic holder (for wall
switch boxes): 105x44x13
mm / 4.13x1.73x0.51 in**

Weight **21 g / 0.74 oz**

Certifications **LVD, RED, EMC, ROHS**

[more info →](#)





GLOBAL



Shelly BLU Wall Switch4



Power supply 1xCR2032 - 3V batteries

Battery life up to 2 years

Connectivity Bluetooth 4.2

Size (HxWxD) 46x46x13 mm /
1.81x1.81x0.51 in

Weight 17 g / 0.6 oz

Certifications LVD, RED, EMC, ROHS

Shelly Adapters for BLU Wall Switch4

Gira, Merten



Busch-Jaeger

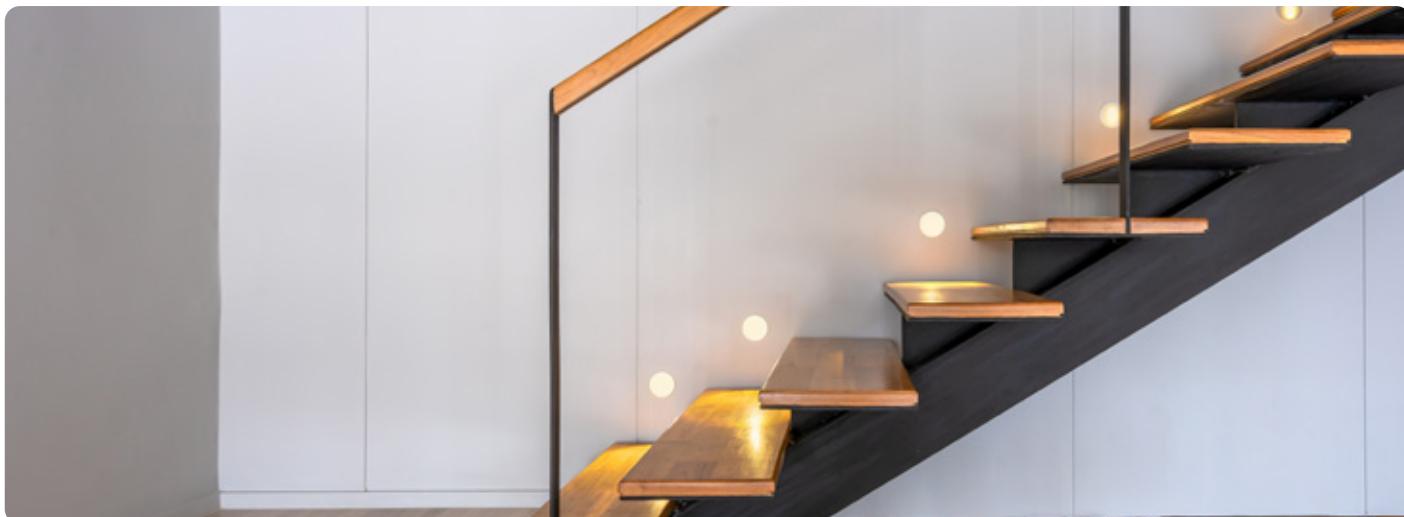


Shelly, Legrand



more info →





GLOBAL



Shelly Plus UNI



Power supply **8-24 V~**
9-28 V=
5 V= (stabilized, via +5 V=
and GND)

Max. control **30 V**
voltage

Max. control **300 mA**
current

Connectivity **W-Fi 4**
Bluetooth 4.2

CPU **ESP32-U4WDH**

Flash Memory **4 MB**

Size (HxWxD) **40x21x7 mm /**
1.57x0.83x0.28 in

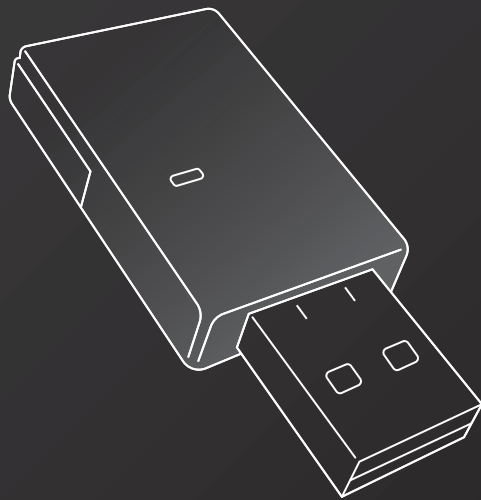
Certifications **LVD, RED, EMC, ROHS**

[more info →](#)





Accessories





GLOBAL



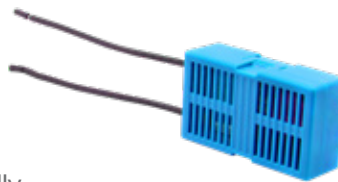
Shelly Bypass

Working voltage **230 V~**
 Compatible with **- Shelly 1L
 - Shelly Dimmer 2**
 Size (HxWxD) **39x23x13 mm /
 1.54x0.91x0.51 inch
 (without wires)**

[more info →](#)



GLOBAL



Shelly Bypass for 1L/2L Gen3

Working voltage **230 V~**
 Compatible with **- Shelly 1L Gen3
 - Shelly 2L Gen3**
 Size (HxWxD) **39x23x13 mm /
 1.54x0.91x0.51 inch
 (without wires)**

[more info →](#)



GLOBAL



Shelly Bypass for Dimmer Gen3

Working voltage **230 V~**
 Compatible with **- Shelly Dimmer Gen3**
 Size (HxWxD) **39x23x13 mm /
 1.54x0.91x0.51 inch
 (without wires)**

[more info →](#)



GLOBAL



Shelly RC Snubber

Capacitance **0.1 μF**
 Resistance **100 Ω**
 Rated voltage **600 V~**

[more info →](#)



GLOBAL



Shelly BLU Gateway

Power supply **5 V==
 (from USB Type-A port)**
 CPU **ESP32**
 Flash **4 MB**

[more info →](#)



GLOBAL



Shelly BLU Gateway Gen3

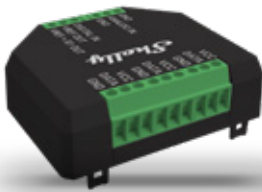
Power supply **5 V==
 (from USB Type-A port)**
 CPU **Shelly ESP32 C3**
 Flash **8 MB**

[more info →](#)





GLOBAL



Shelly Plus Add-on

Add-on for Shelly Plus devices. Can be used with up to five DS18B20 sensors or one DHT22 sensor.

[more info →](#)



GLOBAL



Shelly Temp. Sensor DS18B20

Can be used with Shelly Plus Add-on for measuring precise temperature.

Sizes:
- 1 m
- 3 m

GLOBAL



Shelly LoRa Add-on

Power supply 3.3 V (from a compatible Shelly device)
Size (HxWxD) 40x42x11 mm / 1.58x1.66x0.44 inch
Weight 10 g / 0.4 oz
Range Up to 5 000 m / 16 400 ft (depends on local conditions)

A compact long-range communication add-on for Shelly Gen3 and Gen4 devices*.

*Supporting devices

Shelly Gen3 Devices (1.6 firmware):

- Shelly 1 Gen3
- Shelly 1PM Gen3
- Shelly 2PM Gen3
- Shelly EM Gen3
- Shelly Dimmer 0/1-10V PM Gen3
- Shelly DALI Dimmer Gen3

Shelly Gen4 Devices (1.6 firmware):

- Shelly 1 Gen4
- Shelly 1PM Gen4
- Shelly 2PM Gen4

[more info →](#)



GLOBAL



Shelly LAN Switch

Power supply 110 - 240 V~
Size (HxWxD) 96x53x59 mm / 3.78x2.01x2.32 in
Weight 87 g / 3 oz
Ethernet ports 5 x RJ45 connectors
Certifications LVD, RED, EMC

[more info →](#)





GLOBAL



Shelly
Shelly 50 A Current Transformer Clamp

Working voltage 230 V~

Compatible with
- Shelly Pro EM-50
- Shelly EM Gen3

GLOBAL



Shelly
Shelly 400 A Current Transformer Clamp

GLOBAL



Shelly
Shelly 80 A Solid core Current Transformer

GLOBAL



Shelly
Shelly 120 A Current Transformer Clamp

EU

ANZ



Shelly
Wall Display Stand White / Black

A tabletop stand for Shelly Wall Display setting the display under 35° viewing angle for ease of interaction.

Power supply 230 - 240 V~ 50/60 Hz

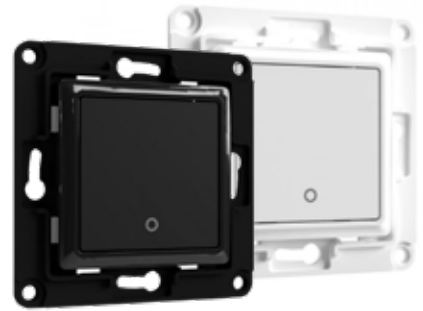
Size (HxWxD) 87x87x113 mm / 3.43x3.43x5.24 inch

[more info →](#)



Wall Switch for smart device

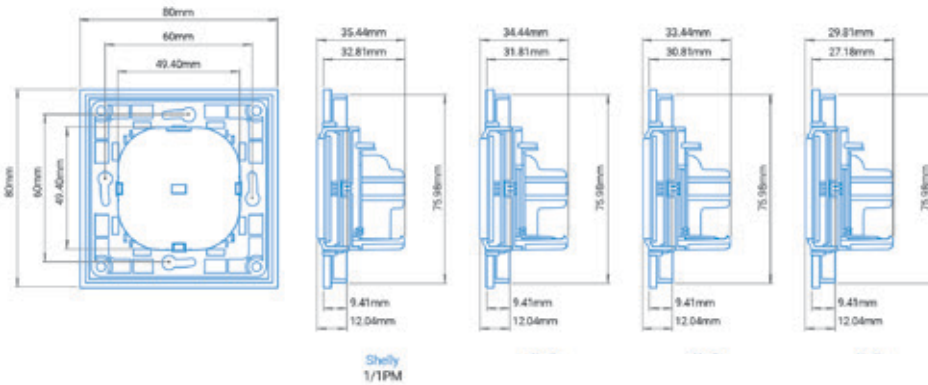
Designed to facilitate your specific automation needs and developed with the smallest details in mind, you can now create a custom wall switch for your Shelly device, and save on space and money!



GLOBAL

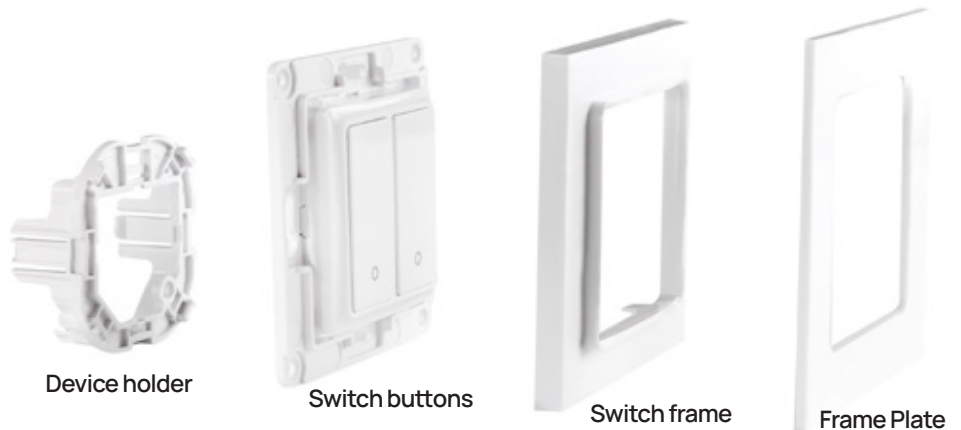
FITS INTO THE TINIEST SPACES!

Compact dimensions and simple wiring that can fit into any existing switch console or even the tiniest spaces.

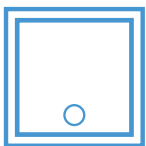


HIGHLY CUSTOMIZABLE!

Each Shelly Wall Switch for Smart device comes with corresponding holders. You can choose the device holder that you need to fulfill your automation project.



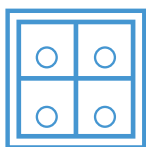
AVAILABLE SWITCHES*:



Shelly Plus, Gen3 and Gen4 Series*

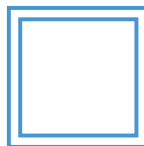


Shelly Plus, Gen3 and Gen4 Series*

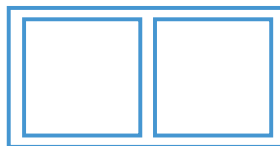


Shelly Plus, Gen3 and Gen4 Series*

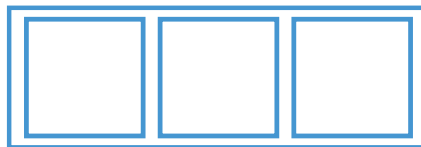
AVAILABLE FRAMES*:



Single frame



Double frame



Triple frame

AVAILABLE COLORS:



White



Black

*Shelly Wall switches and Shelly Wall frames are sold separately!

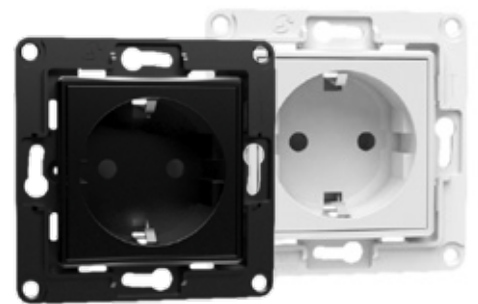


Shelly Wall Socket EU

EU

It can fit into any existing wall socket console or even the tiniest spaces due to its compact dimensions and simple wiring. Type F/Shuko.

* There is no relay device included in the package.

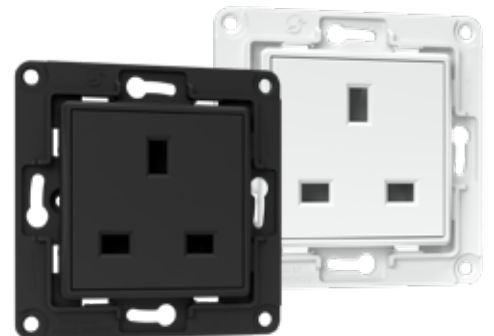


Shelly Wall Socket UK

UK

Shelly Wall Socket can fit into any existing wall socket console or even the tiniest spaces due to its compact dimensions and simple wiring. When combined with the Shelly Wall Switch, your home acquires a beautiful, unified interior design. United Kingdom standard. Type G/BS 1363

* There is no relay device included in the package.



Shelly

Explore the
POSSIBILITIES